

SharkBite Female Back Plate Elbow

A high performance, time and labour-saving solution for connecting compressed air and pneumatic piping systems.

Overview

The SharkBite Air & Pneumatics range enables fast, simple and reliable pipe connections. Available in 10 to 54mm sizes, the robust brass-body fittings can withstand high pressure and a range of system requirements, making it ideal for small to large commercial and industrial applications.

Using a simple push-fit action, pipes are instantly joined without the need for tools, silicon, hot works, solder or glue. Fittings can also be disconnected with a secure demounting tool, making system extensions and modifications quick and easy.

Designed to securely and firmly grip the system's anodised aluminium pipe, SharkBite Air & Pneumatics provides an air tight seal. The range is also compatible with powder coated aluminium, copper, PEX-a or nylon pipe.

Features

- Push-fit connection ends
- Engineered brass body
- Nitrile O-Ring and stainless steel grab ring
- 18-20 bar pressure rating
- Secure demounting tool

Benefits

- Durable solution that withstands high pressure
- Instant, tool-free, push-fit connection
- No hot works, silicon, solder or glue
- Quick and easy system reconfiguration and extension, with minimal downtime
- A versatile solution that connects to metal or plastic pipe



Product code	Size	Description	Bag qty
SBA121515FBP	15mm x 1/2" FBSP	Female Back Plate Elbow	1
SBA122220FBP	22mm x 3/4" FBSP	Female Back Plate Elbow	1

Approvals

The design and working parameters of the SharkBite Air & Pneumatics fitting range fall within the SEP (Sound Engineering Practice) range of the Pressure Equipment Directive.

Rigorous manufacturing and quality control, as well as long-term internal product testing, ensure the durability and seamless performance of the SharkBite Air & Pneumatics fittings.

SharkBite Female Back Plate Elbow

Working pressures and temperatures

Size	Pipe	Pressure/temperature		
10mm	Anodised Aluminium	N/A	N/A	N/A
	Powder Coated Aluminium	N/A	N/A	N/A
	Nylon	15 Bar / -20°C	15 Bar / 20°C	8 Bar / 65°C
	PEX-a	N/A	N/A	N/A
	Copper	16 Bar / -20°C	16 Bar / 20°C	10 Bar / 65°C
15mm	Anodised Aluminium	20 Bar / -20°C	20 Bar / 20°C	16 Bar / 65°C
	Powder Coated Aluminium	20 Bar / -20°C	20 Bar / 20°C	16 Bar / 65°C
	Nylon	15 Bar / -20°C	15 Bar / 20°C	8 Bar / 65°C
	PEX-a	16 Bar / 20°C	16 Bar / 20°C	9 Bar / 65°C
	Copper	20 Bar / -20°C	20 Bar / 20°C	16 Bar / 65°C
22mm	Anodised Aluminium	20 Bar / -20°C	20 Bar / 20°C	16 Bar / 65°C
	Powder Coated Aluminium	20 Bar / -20°C	20 Bar / 20°C	16 Bar / 65°C
	Nylon	14 Bar / -20°C	14 Bar / 20°C	7 Bar / 65°C
	PEX-a	16 Bar / 20°C	16 Bar / 20°C	9 Bar / 65°C
	Copper	20 Bar / -20°C	20 Bar / 20°C	16 Bar / 65°C
28mm	Anodised Aluminium	20 Bar / -20°C	20 Bar / 20°C	16 Bar / 65°C
	Powder Coated Aluminium	20 Bar / -20°C	20 Bar / 20°C	16 Bar / 65°C
	Nylon	14 Bar / -20°C	14 Bar / 20°C	7 Bar / 65°C
	PEX-a	16 Bar / 20°C	16 Bar / 20°C	9 Bar / 65°C
	Copper	20 Bar / -20°C	20 Bar / 20°C	16 Bar / 65°C
35mm	Anodised Aluminium	20 Bar / -20°C	20 Bar / 20°C	16 Bar / 65°C
	Powder Coated Aluminium	20 Bar / -20°C	20 Bar / 20°C	16 Bar / 65°C
	Nylon	N/A	N/A	N/A
	PEX-a	N/A	N/A	N/A
	Copper	20 Bar / -20°C	20 Bar / 20°C	16 Bar / 65°C
42mm	Anodised Aluminium	20 Bar / -20°C	20 Bar / 20°C	16 Bar / 65°C
	Powder Coated Aluminium	20 Bar / -20°C	20 Bar / 20°C	16 Bar / 65°C
	Nylon	N/A	N/A	N/A
	PEX-a	N/A	N/A	N/A
	Copper	20 Bar / -20°C	20 Bar / 20°C	16 Bar / 65°C
54mm	Anodised Aluminium	18 Bar / -20°C	18 Bar / 20°C	14 Bar / 65°C
	Powder Coated Aluminium	18 Bar / -20°C	18 Bar / 20°C	14 Bar / 65°C
	Nylon	N/A	N/A	N/A
	PEX-a	N/A	N/A	N/A
	Copper	18 Bar / -20°C	18 Bar / 20°C	14 Bar / 65°C

Materials

Body 10mm - 28mm	CW602N Brass
Body 35mm - 54mm	CW617N Brass
O-Ring	Nitrile
Cartridge Ring - 10mm	Acetal
Cartridge Ring - 15-28mm	304 Stainless Steel
Cartridge Ring - 35-54mm	Polyphenylsulfones (PPSU)
Grab ring	316 Stainless Steel
Alignment ring - 10 - 28mm	Acetal
Disconnecting ring - 10 28mm	Acetal
Disconnecting ring - 35 - 54mm	PPSU

Dimensions – All measurements in mm unless otherwise stated

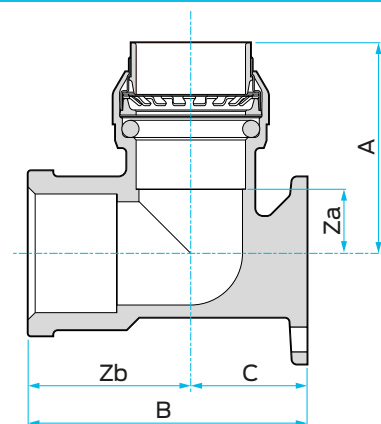

Product Code	Size	A	Za	B	Zb	C
SBA121515FBP	15mm x 1/2" FBSP	35	12	45	11	20
SBA122220FBP	22mm x 3/4" FBSP	42	13	57	15	24